

SEMiX106GD12T4p

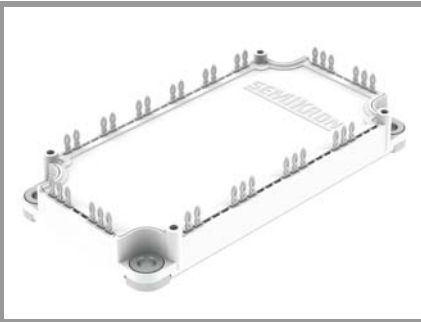

SEMiX® 6p

Trench IGBT Modules

SEMiX106GD12T4p

Features*

- Press Fit
- Homogeneous Si
- Trench = Trenchgate technology
- $V_{CE(sat)}$ with positive temperature coefficient
- High short circuit capability
- UL recognised file no. E63532

Typical Applications

- AC inverter drives
- UPS
- Electronic Welding

Remarks

- Case temperature limited to $T_C=125^\circ\text{C}$ max.
- V_{isol} between temperature sensor and power section is only 2500V
- Product reliability results valid for $T_j \leq 150^\circ\text{C}$ (recommended $T_{jop} = -40 \dots 150^\circ\text{C}$)

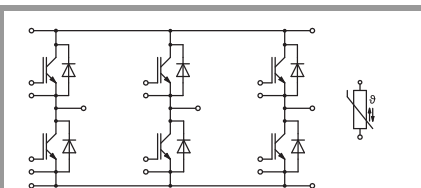

GD

Absolute Maximum Ratings			
Symbol	Conditions	Values	Unit
IGBT			
V_{CES}	$T_j = 25^\circ\text{C}$	1200	V
I_C	$T_j = 175^\circ\text{C}$	$T_c = 25^\circ\text{C}$	167
		$T_c = 80^\circ\text{C}$	129
I_{Cnom}		100	A
I_{CRM}	$I_{CRM} = 3 \times I_{Cnom}$	300	A
V_{GES}		-20 ... 20	V
t_{psc}	$V_{CC} = 800\text{ V}$ $V_{GE} \leq 20\text{ V}$ $V_{CES} \leq 1200\text{ V}$	$T_j = 150^\circ\text{C}$	10
			μs
T_j		-40 ... 175	$^\circ\text{C}$
Inverse diode			
V_{RRM}	$T_j = 25^\circ\text{C}$	1200	V
I_F	$T_j = 175^\circ\text{C}$	$T_c = 25^\circ\text{C}$	121
		$T_c = 80^\circ\text{C}$	91
I_{Fnom}		100	A
I_{FRM}	$I_{FRM} = 2 \times I_{Fnom}$	200	A
I_{FSM}	$t_p = 10\text{ ms, sin } 180^\circ, T_j = 25^\circ\text{C}$	550	A
T_j		-40 ... 175	$^\circ\text{C}$
Module			
$I_{t(RMS)}$	per connector pin	50	A
T_{stg}		-40 ... 125	$^\circ\text{C}$
V_{isol}	AC sinus 50Hz, $t = 1\text{ min}$	4000	V

Characteristics					
Symbol	Conditions	min.	typ.	max.	Unit
IGBT					
$V_{CE(sat)}$	$I_C = 100\text{ A}$ $V_{GE} = 15\text{ V}$ chipllevel	$T_j = 25^\circ\text{C}$	1.80	2.05	V
		$T_j = 150^\circ\text{C}$	2.10	2.40	V
V_{CE0}	chipllevel	$T_j = 25^\circ\text{C}$	0.8	0.9	V
		$T_j = 150^\circ\text{C}$	0.7	0.8	V
r_{CE}	$V_{GE} = 15\text{ V}$ chipllevel	$T_j = 25^\circ\text{C}$	10.0	11.5	$\text{m}\Omega$
		$T_j = 150^\circ\text{C}$	14	16.0	$\text{m}\Omega$
$V_{GE(th)}$	$V_{GE}=V_{CE}, I_C = 3.8\text{ mA}$	5	5.8	6.5	V
I_{CES}	$V_{GE} = 0\text{ V}, V_{CE} = 1200\text{ V}, T_j = 25^\circ\text{C}$			1	mA
C_{ies}	$V_{CE} = 25\text{ V}$ $V_{GE} = 0\text{ V}$	$f = 1\text{ MHz}$	6.2		nF
C_{oes}		$f = 1\text{ MHz}$	0.41		nF
C_{res}		$f = 1\text{ MHz}$	0.35		nF
Q_G	$V_{GE} = -8\text{ V} \dots +15\text{ V}$		565		nC
R_{Gint}	$T_j = 25^\circ\text{C}$		7.5		Ω
$t_{d(on)}$	$V_{CC} = 600\text{ V}$ $I_C = 100\text{ A}$	$T_j = 150^\circ\text{C}$	150		ns
t_r	$V_{GE} = +15/-15\text{ V}$	$T_j = 150^\circ\text{C}$	28		ns
E_{on}	$R_{G on} = 1.6\ \Omega$	$T_j = 150^\circ\text{C}$	8		mJ
$t_{d(off)}$	$R_{G off} = 1.6\ \Omega$	$T_j = 150^\circ\text{C}$	415		ns
t_f	$di/dt_{on} = 3960\text{ A}/\mu\text{s}$ $di/dt_{off} = 1120\text{ A}/\mu\text{s}$	$T_j = 150^\circ\text{C}$	66		ns
E_{off}	$dv/dt = 3300\text{ V}/\mu\text{s}$ $L_s = 25\text{ nH}$	$T_j = 150^\circ\text{C}$	11.5		mJ
$R_{th(j-c)}$	per IGBT			0.25	K/W
$R_{th(c-s)}$	per IGBT ($\lambda_{grease}=0.81\text{ W}/(\text{m}^2\text{K})$)		0.06		K/W

SEMiX106GD12T4p

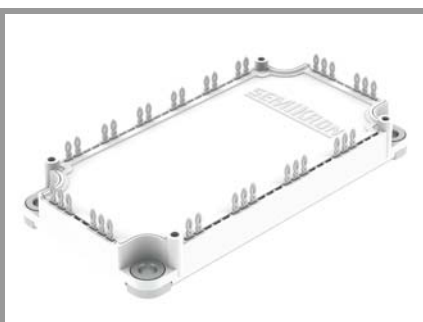

SEMiX® 6p

Trench IGBT Modules

SEMiX106GD12T4p

Features*

- Press Fit
- Homogeneous Si
- Trench = Trenchgate technology
- $V_{CE(sat)}$ with positive temperature coefficient
- High short circuit capability
- UL recognised file no. E63532

Typical Applications

- AC inverter drives
- UPS
- Electronic Welding

Remarks

- Case temperature limited to $T_C=125^\circ\text{C}$ max.
- V_{isol} between temperature sensor and power section is only 2500V
- Product reliability results valid for $T_j \leq 150^\circ\text{C}$ (recommended $T_{jop} = -40 \dots 150^\circ\text{C}$)

Characteristics			min.	typ.	max.	Unit
Symbol	Conditions					
Inverse diode						
$V_F = V_{EC}$	$I_F = 100 \text{ A}$ $V_{GE} = 0 \text{ V}$ chipllevel	$T_j = 25^\circ\text{C}$		2.20	2.52	V
		$T_j = 150^\circ\text{C}$		2.20	2.47	V
V_{F0}	chipllevel	$T_j = 25^\circ\text{C}$		1.3	1.50	V
		$T_j = 150^\circ\text{C}$		0.90	1.10	V
r_F	chipllevel	$T_j = 25^\circ\text{C}$		9.0	10	m Ω
		$T_j = 150^\circ\text{C}$		13	14	m Ω
I_{RRM}	$I_F = 100 \text{ A}$	$T_j = 150^\circ\text{C}$		161		A
Q_{rr}	$di/dt_{off} = 4000 \text{ A}/\mu\text{s}$	$T_j = 150^\circ\text{C}$		16		μC
E_{rr}	$V_{GE} = -15 \text{ V}$ $V_{CC} = 600 \text{ V}$	$T_j = 150^\circ\text{C}$		6.5		mJ
$R_{th(j-c)}$	per diode				0.48	K/W
$R_{th(c-s)}$	per diode ($\lambda_{grease}=0.81 \text{ W}/(\text{m}^2\text{K})$)			0.08		K/W
Module						
L_{CE}				18		nH
$R_{CC'+EE'}$	measured per switch	$T_C = 25^\circ\text{C}$		1		m Ω
		$T_C = 125^\circ\text{C}$		1.4		m Ω
$R_{th(c-s)1}$	calculated without thermal coupling ($\lambda_{grease}=0.81 \text{ W}/(\text{m}^2\text{K})$)			0.006		K/W
$R_{th(c-s)2}$	including thermal coupling, T_s underneath module ($\lambda_{grease}=0.81 \text{ W}/(\text{m}^2\text{K})$)			0.009		K/W
M_s	to heat sink (M5)		3		6	Nm
M_t				-		Nm
				-		Nm
w				300		g
Temperature Sensor						
R_{100}	$T_c=100^\circ\text{C}$ ($R_{25}=5 \text{ k}\Omega$)			$493 \pm 5\%$		Ω
$B_{100/125}$	$R(T)=R_{100}\exp[B_{100/125}(1/T-1/T_{100})]$; T[K];			$3550 \pm 2\%$		K

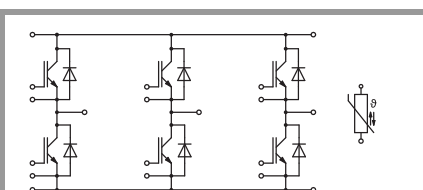

GD

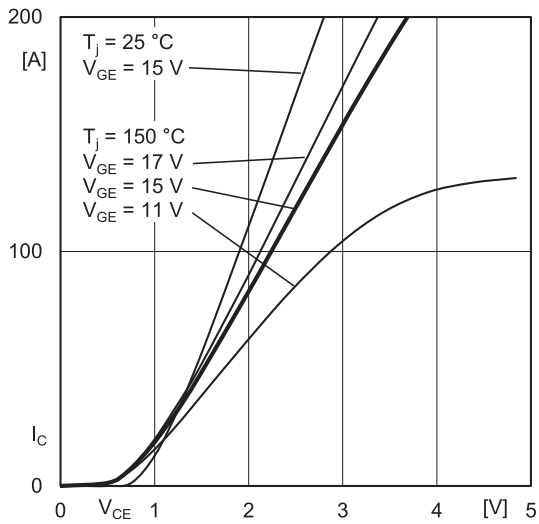

Fig. 1: Typ. output characteristic, inclusive $R_{CC'+EE'}$

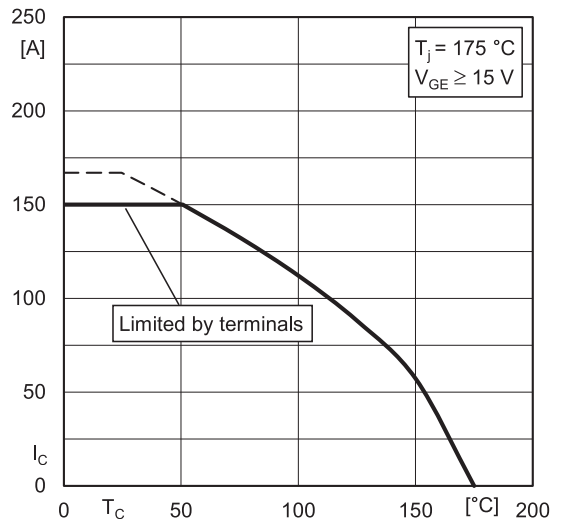

Fig. 2: Rated current vs. temperature $I_C = f(T_C)$

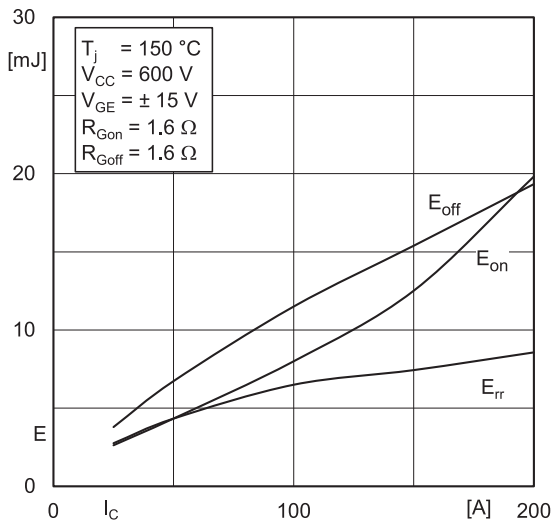

Fig. 3: Typ. turn-on /-off energy = $f(I_C)$

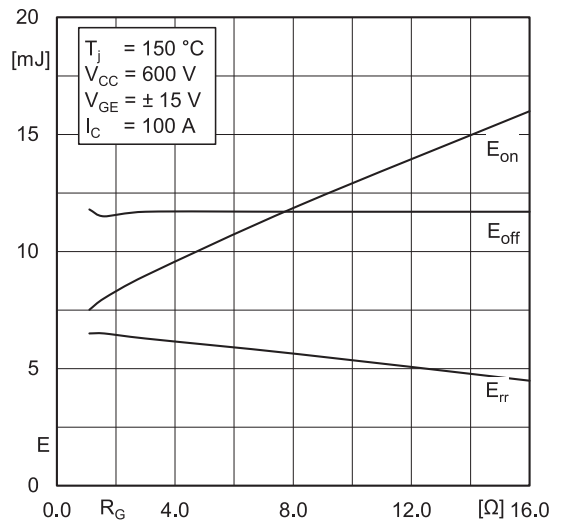

Fig. 4: Typ. turn-on /-off energy = $f(R_G)$

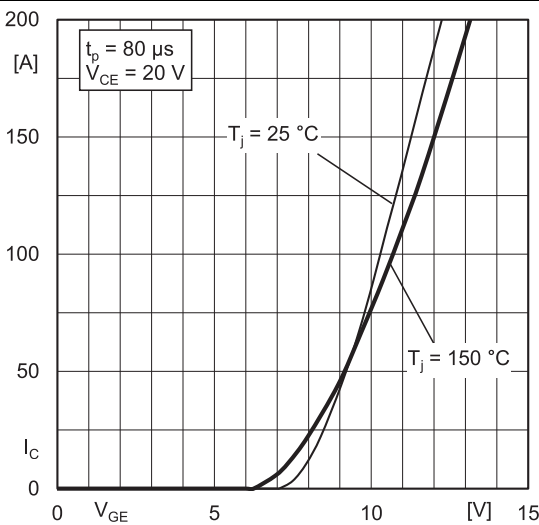

Fig. 5: Typ. transfer characteristic

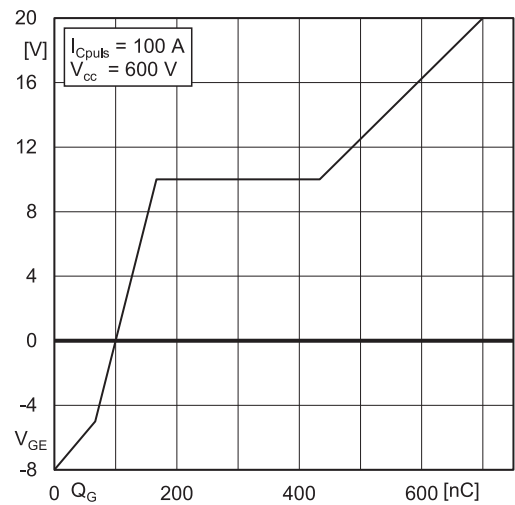

Fig. 6: Typ. gate charge characteristic

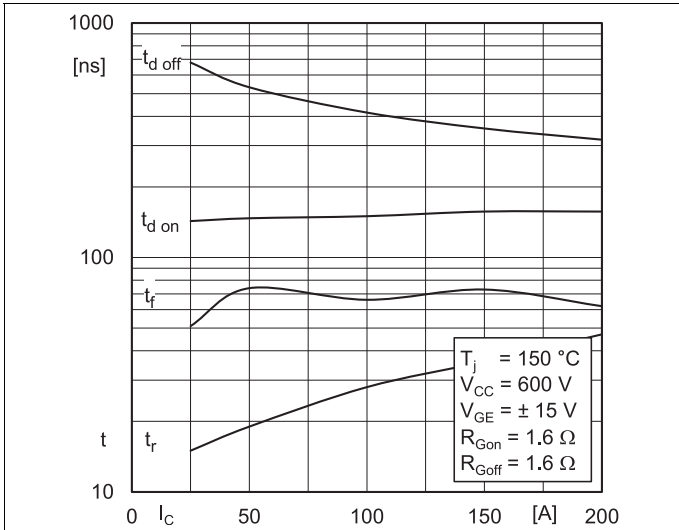

Fig. 7: Typ. switching times vs. I_C

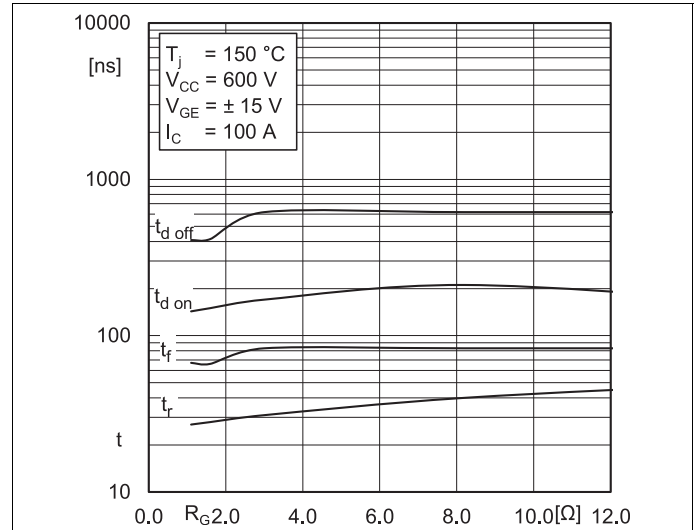

Fig. 8: Typ. switching times vs. gate resistor R_G

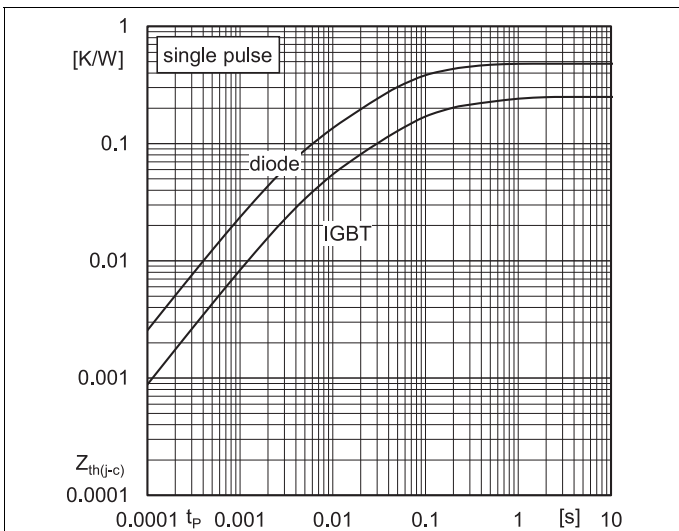

Fig. 9: Transient thermal impedance

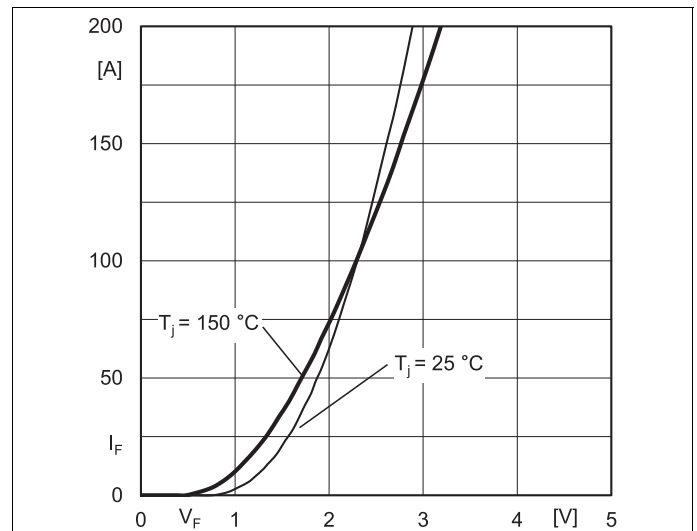

Fig. 10: Typ. CAL diode forward charact., incl. R_{CC+EE}

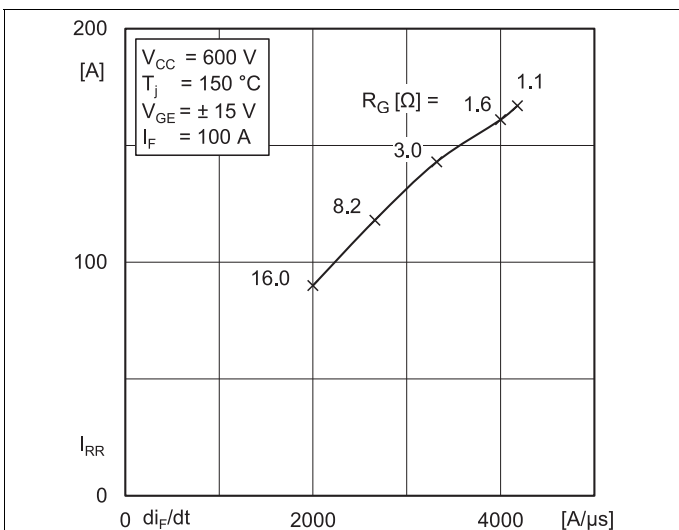

Fig. 11: Typ. CAL diode peak reverse recovery current

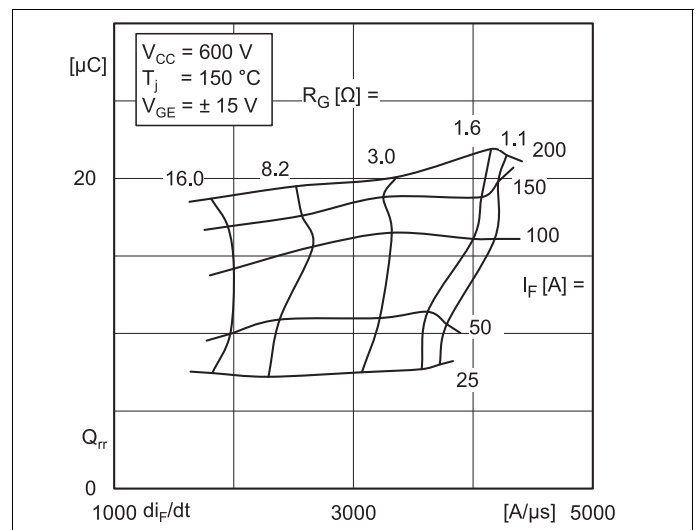
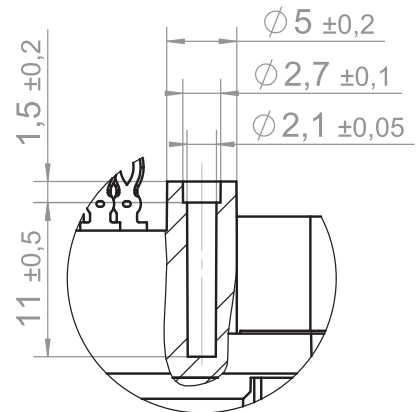
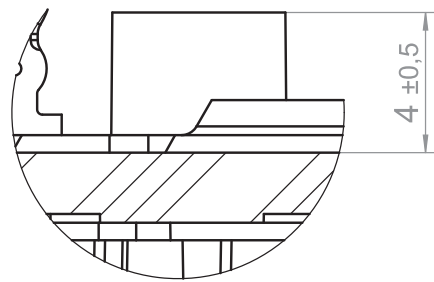
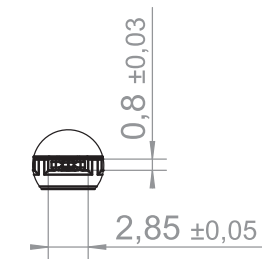
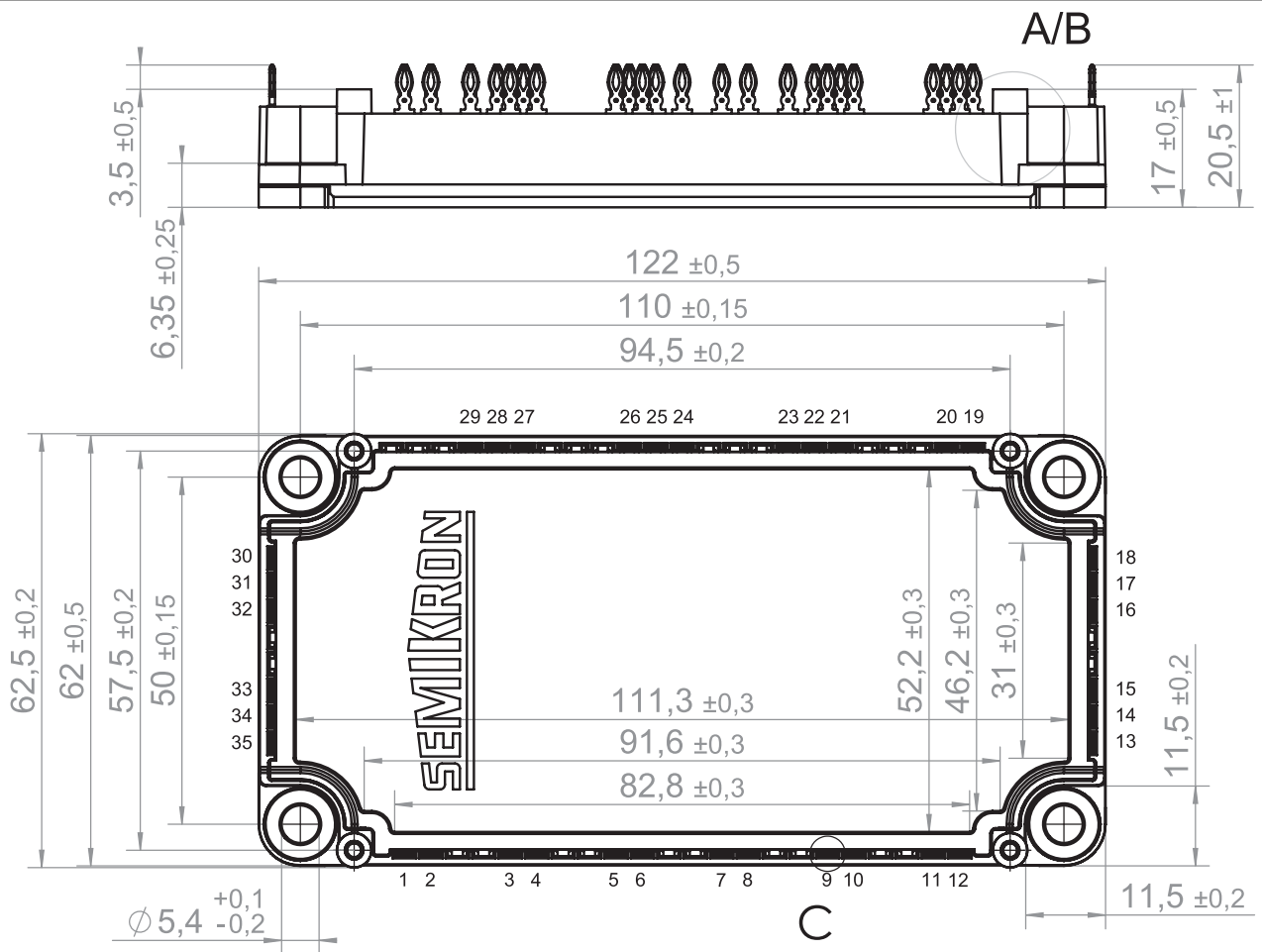
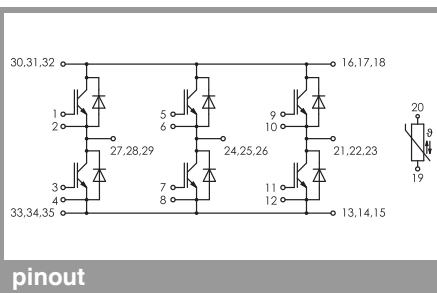

Fig. 12: Typ. CAL diode recovery charge



B (5 : 1)
Cross-sectional plane in the middle of the module

A (2 : 1)
Cut-out shows section through the center of the PCB-dome



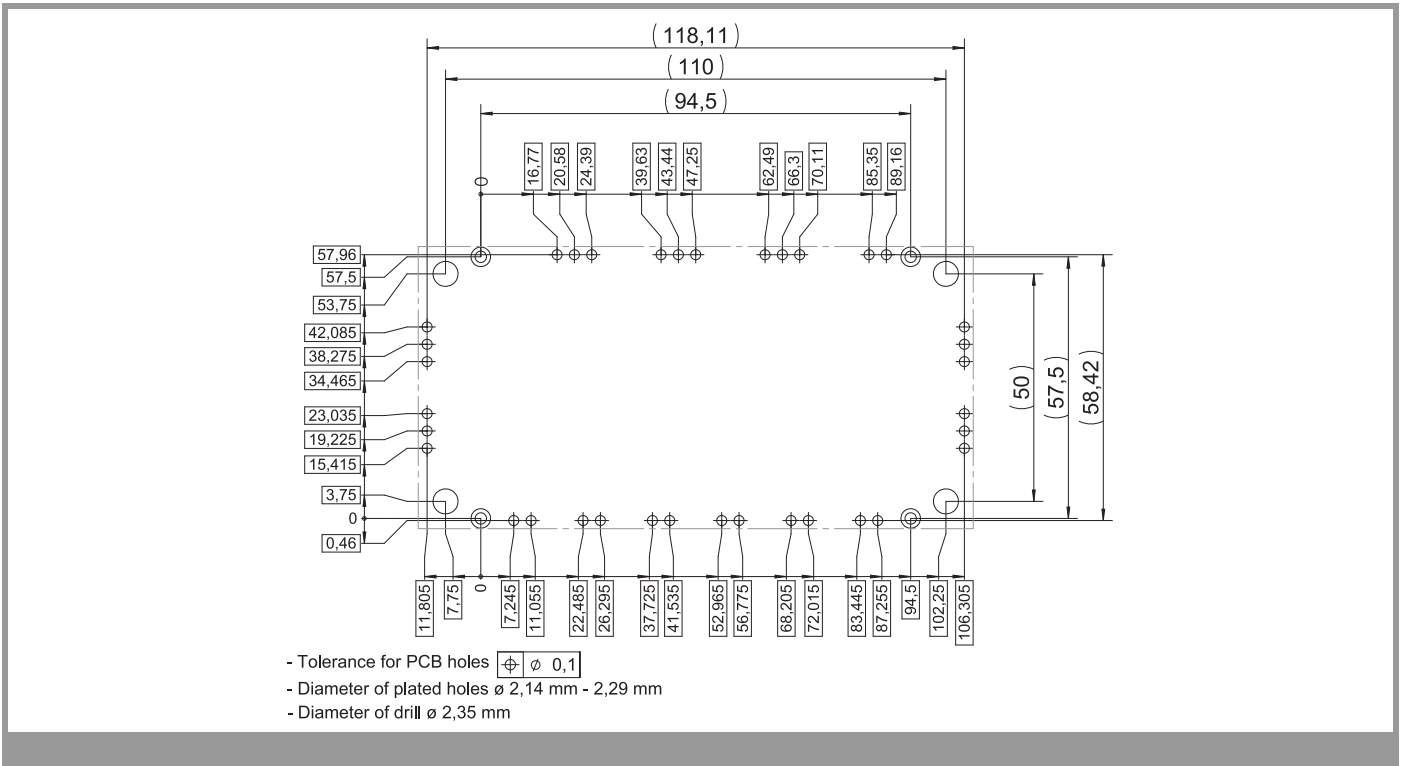

This is an electrostatic discharge sensitive device (ESDS), international standard IEC 60747-1, chapter IX.

*IMPORTANT INFORMATION AND WARNINGS

The specifications of SEMIKRON products may not be considered as guarantee or assurance of product characteristics ("Beschaffheitsgarantie"). The specifications of SEMIKRON products describe only the usual characteristics of products to be expected in typical applications, which may still vary depending on the specific application. Therefore, products must be tested for the respective application in advance. Application adjustments may be necessary. The user of SEMIKRON products is responsible for the safety of their applications embedding SEMIKRON products and must take adequate safety measures to prevent the applications from causing a physical injury, fire or other problem if any of SEMIKRON products become faulty. The user is responsible to make sure that the application design is compliant with all applicable laws, regulations, norms and standards. Except as otherwise explicitly approved by SEMIKRON in a written document signed by authorized representatives of SEMIKRON, SEMIKRON products may not be used in any applications where a failure of the product or any consequences of the use thereof can reasonably be expected to result in personal injury. No representation or warranty is given and no liability is assumed with respect to the accuracy, completeness and/or use of any information herein, including without limitation, warranties of non-infringement of intellectual property rights of any third party. SEMIKRON does not assume any liability arising out of the applications or use of any product; neither does it convey any license under its patent rights, copyrights, trade secrets or other intellectual property rights, nor the rights of others. SEMIKRON makes no representation or warranty of non-infringement or alleged non-infringement of intellectual property rights of any third party which may arise from applications. Due to technical requirements our products may contain dangerous substances. For information on the types in question please contact the nearest SEMIKRON sales office. This document supersedes and replaces all information previously supplied and may be superseded by updates. SEMIKRON reserves the right to make changes.