

# Board 1 SKYPER 32PRO R

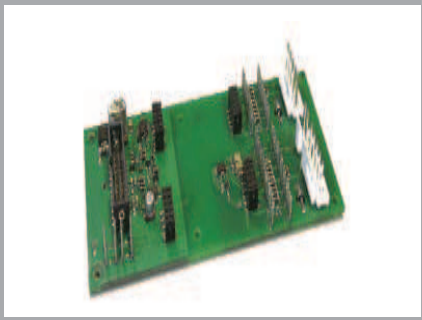

**SKYPER®**

## Adaptor board

### Board 1 SKYPER 32PRO R

#### Preliminary Data

#### Features

- Two output channels
- Failure management

#### Typical Applications\*

- Adaptor board for SKYPER 32 IGBT drivers in bridge circuits for industrial applications
- DC bus up to 1200V

#### Footnotes

All characteristics listed in the data sheet are guilty for the use with SKYPER 32. Please consider the derating of the ambient temperature. Please refer to the datasheet of SKYPER 32 for further information.

Absolute Maximum Ratings			
Symbol	Conditions	Values	Unit
V <sub>s</sub>	Supply voltage primary	16	V
I <sub>outPEAK</sub>	Output peak current	15	A
I <sub>outAVmax</sub>	Output average current	50	mA
f <sub>max</sub>	max. switching frequency	50	kHz
V <sub>CE</sub>	Collector emitter voltage sense across the IGBT	1700	V
V <sub>isol IO</sub>	Isolation test voltage input - output (AC, rms, 2s)	4000	V
V <sub>isolPD</sub>	Partial discharge extinction voltage, rms, Q <sub>PD</sub> ≤ 10pC	1500	V
V <sub>isol12</sub>	Isolation test voltage output 1 - output 2 (AC, rms, 2s)	1500	V
R <sub>Gon min</sub>		1.5	Ω
R <sub>Goff min</sub>	Minimum rating for external R <sub>Goff</sub>	1.5	Ω
T <sub>op</sub>	Operating temperature	-25 ... 85	°C
T <sub>stg</sub>	Storage temperature	-25 ... 85	°C

Characteristics					
Symbol	Conditions	min.	typ.	max.	Unit
V <sub>s</sub>	Supply voltage primary side	14.4	15	15.6	V
V <sub>j</sub>	input signal voltage on / off		15 / 0		V
V <sub>IT+</sub>	Input threshold voltage HIGH			12.3	V
V <sub>IT-</sub>	Input threshold voltage (LOW)	4.6			V
V <sub>G(on)</sub>	Turn on gate voltage output		15		V
V <sub>G(off)</sub>	Turn off gate voltage output		-7		V
t <sub>d(on)IO</sub>	Input-output turn-on propagation time		1.2		μs
t <sub>d(off)IO</sub>	Input-output turn-off propagation time		1.2		μs

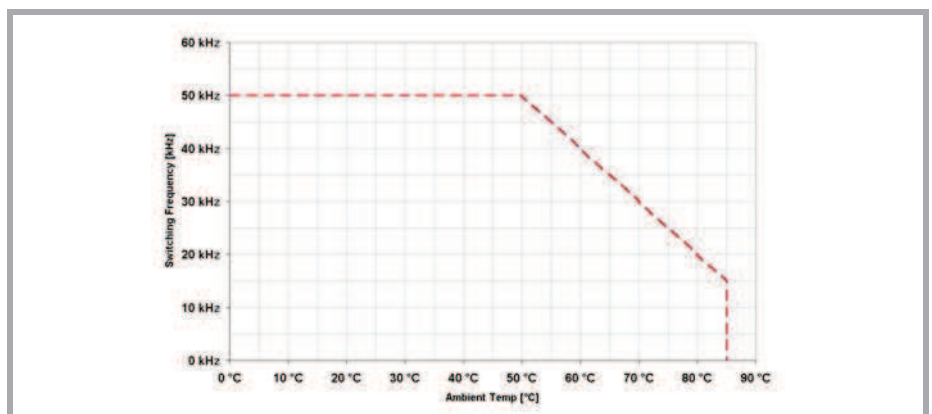

Derating

This is an electrostatic discharge sensitive device (ESDS), international standard IEC 60747-1, Chapter IX

\* The specifications of our components may not be considered as an assurance of component characteristics. Components have to be tested for the respective application. Adjustments may be necessary. The use of SEMIKRON products in life support appliances and systems is subject to prior specification and written approval by SEMIKRON. We therefore strongly recommend prior consultation of our personal.

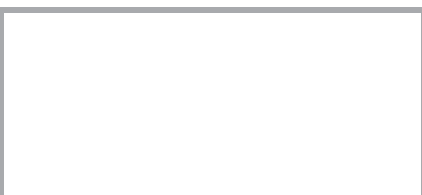

Adaptor board

# Adaptor Board 1 SKYPER® 32PRO R

## Technical Explanations

Revision 02

This Technical Explanation is valid for the following parts:

part number	type	date code (YYWW)
L6100231	Board 1 SKYPER® 32PRO R	≥ 1004

Related documents:

title
Technical Explanations SKYPER® 32PRO R

Prepared by: Johannes Krapp

### Content

Application and Handling Instructions .....	3
Further application support .....	3
General Description .....	3
Dimensions .....	4
Component Placement Layout .....	4
PIN Array (not SKiiP® compatible) .....	5
PIN Array – Secondary Side .....	6
Signal IF_CMN_nHALT .....	7
Setting Dead Time .....	7
Setting Dynamic Short Circuit Protection .....	7
Collector Series Resistance .....	8
Adaptation Gate Resistors .....	8
Setting Soft Turn-Off .....	8
Over Temperature Protection Circuit (OTP) .....	9
Mounting Notes .....	9
Schematics .....	10
Parts List .....	12

# Board 1 SKYPER<sup>®</sup> 32PRO R - Technical Explanations

## Please note:

All values in this technical explanation are typical values. Typical values are the average values expected in large quantities and are provided for information purposes only. These values can and do vary in different applications. All operating parameters should be validated by user's technical experts for each application.

## Application and Handling Instructions

- Please provide for static discharge protection during handling. As long as the hybrid driver is not completely assembled, the input terminals have to be short-circuited. Persons working with devices have to wear a grounded bracelet. Any synthetic floor coverings must not be statically chargeable. Even during transportation the input terminals have to be short-circuited using, for example, conductive rubber. Worktables have to be grounded. The same safety requirements apply to MOSFET- and IGBT-modules.
- Any parasitic inductances within the DC-link have to be minimised. Over-voltages may be absorbed by C- or RCD-snubber networks between main terminals for PLUS and MINUS of the power module.
- When first operating a newly developed circuit, SEMIKRON recommends to apply low collector voltage and load current in the beginning and to increase these values gradually, observing the turn-off behaviour of the free-wheeling diode and the turn-off voltage spikes generated across the IGBT. An oscillographic control will be necessary. Additionally, the case temperature of the module has to be monitored. When the circuit works correctly under rated operation conditions, short-circuit testing may be done, starting again with low collector voltage.
- It is important to feed any errors back to the control circuit and to switch off the device immediately in failure events. Repeated turn-on of the IGBT into a short circuit with a high frequency may destroy the device.
- The inputs of the hybrid driver are sensitive to over-voltage. Voltages higher than  $V_S + 0,3V$  or below  $-0,3V$  may destroy these inputs. Therefore, control signal over-voltages exceeding the above values have to be avoided.
- The connecting leads between hybrid driver and the power module should be as short as possible (max. 20cm), the driver leads should be twisted.

## Further application support

Latest information is available at <http://www.semikron.com>. For design support please read the SEMIKRON Application Manual Power Modules available at <http://www.semikron.com>.

## General Description

The Board 1 SKYPER<sup>®</sup> 32PRO is an adaptor board for the IGBT module e.g. SEMITRANS<sup>™</sup>, SEMiX<sup>®</sup> (solder pin version). The board can be customized allowing adaptation and optimization to the used IGBT module. The switching characteristic of the IGBT can be influenced through user settings, e.g. changing turn-on and turn-off speed by variation of  $R_{Gon}$  and  $R_{Goff}$ . Furthermore, it is possible to adjust the monitoring level and blanking time for the DSCP, soft turn-off behaviour as well as an over temperature trip level by using the temperature sensor integrated in SEMiX<sup>®</sup> modules (see Technical Explanations SKYPER<sup>®</sup> 32PRO).

## Please note:

This technical explanation is based on the Technical Explanations for SKYPER<sup>®</sup> 32PRO. Please read the Technical Explanations SKYPER<sup>®</sup> 32PRO before using the Adaptor Board.

Board 1 SKYPER<sup>®</sup> 32PRO

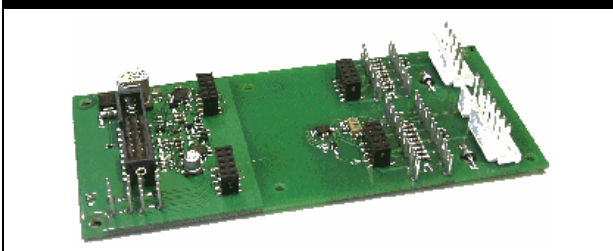

# Board 1 SKYPER<sup>®</sup> 32PRO R - Technical Explanations

## Dimensions

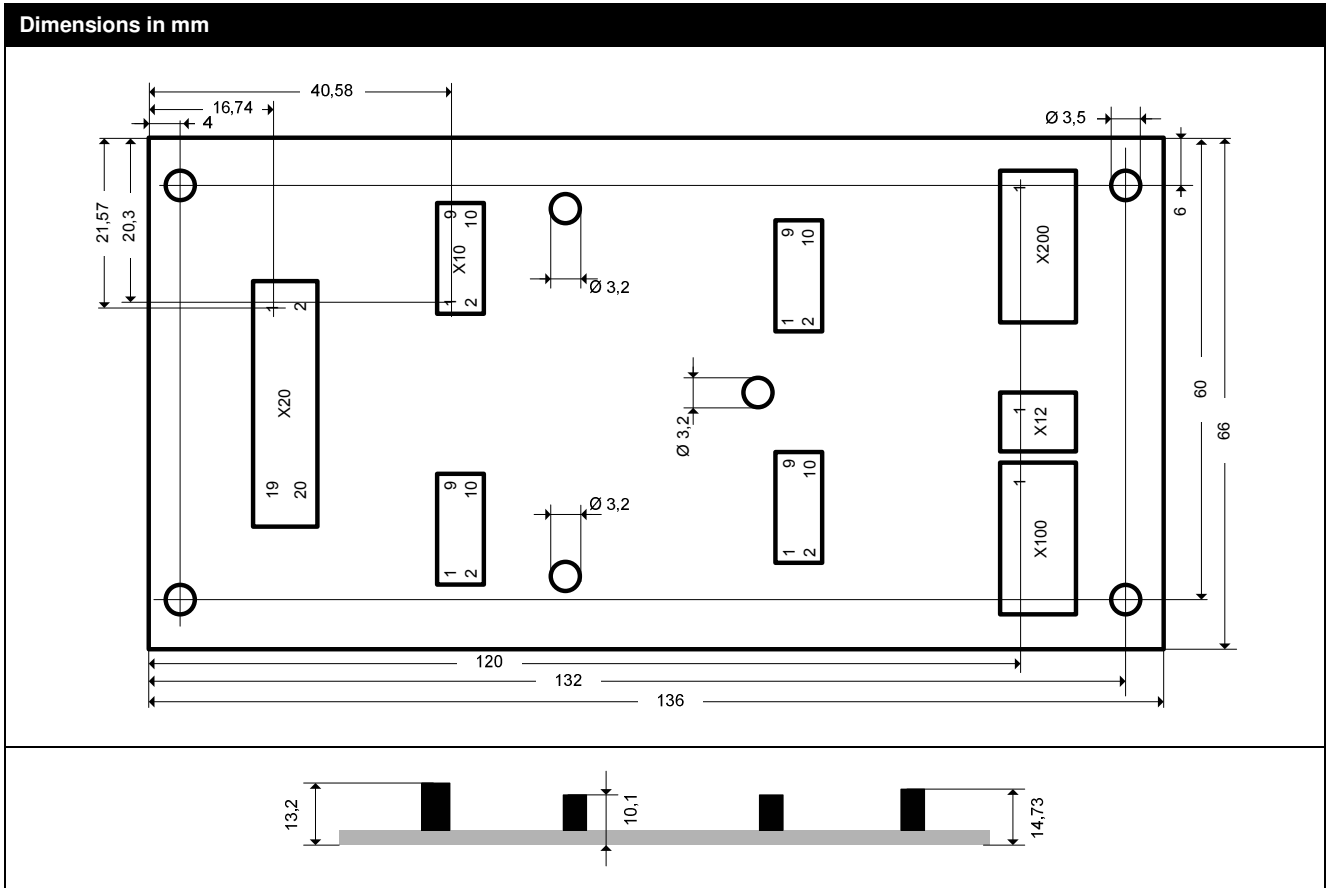

## Component Placement Layout

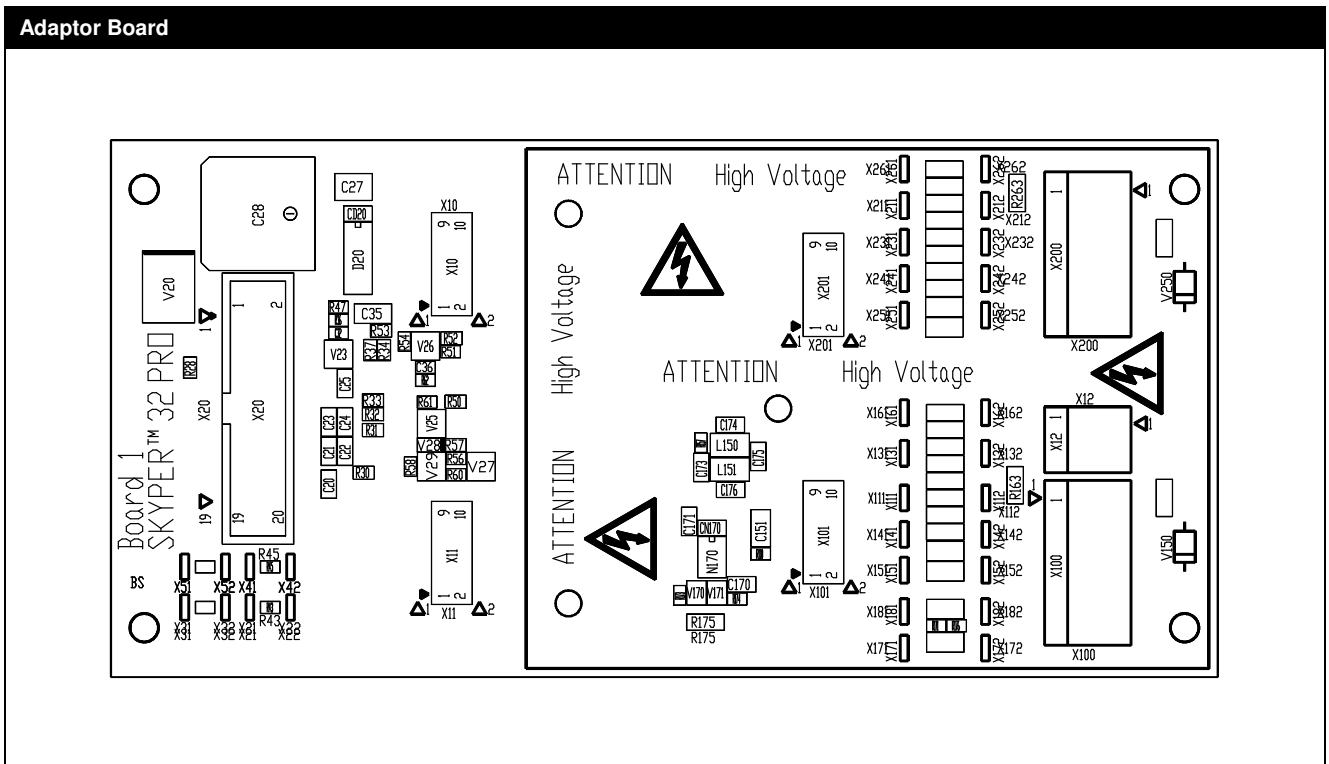

# Board 1 SKYPER® 32PRO R - Technical Explanations

**PIN Array** (not SKiiP® compatible)

Connector X20 (ODU FLAKAFIX 511.068.803.020)	
	<p>Product information of suitable female connectors and distributor contact information is available at e.g. <a href="http://www.harting.com">http://www.harting.com</a> (part number 09 18 520 6 813).</p>

PIN	Signal	Function	Specification
X20:01	IF_PWR_15P	Drive power supply	Stabilised +15V ±4%
X20:02	IF_PWR_GND	GND for power supply	
X20:03	IF_PWR_15P	Drive power supply	Stabilised +15V ±4%
X20:04	IF_PWR_GND	GND for power supply	
X20:05	IF_PWR_15P	Drive power supply	Stabilised +15V ±4%
X20:06	IF_PWR_GND	GND for power supply	
X20:07	reserved		
X20:08	IF_PWR_GND	GND for power supply	
X20:09	IF_CMN_nHALT	Driver core status signal (bidirectional signal with dominant recessive behaviour)	Digital 15V logic; LOW (dominant) = driver disabled; HIGH (recessive) = ready to operate
X20:10	reserved		
X20:11	reserved		
X20:12	IF_CMN_GND	GND for signal IF_CMN_nHALT	
X20:13	reserved		
X20:14	reserved		
X20:15	IF_HB_TOP	Switching signal input (TOP switch)	Digital 15 V logic; 10 kOhm impedance; LOW = TOP switch off; HIGH = TOP switch on
X20:16	IF_HB_BOT	Switching signal input (BOTTOM switch)	Digital 15 V logic; 10 kOhm impedance; LOW = BOT switch off; HIGH = BOT switch on
X20:17	reserved		
X20:18	IF_HB_GND	GND for signals IF_HB_TOP & IF_HB_BOT	
X20:19	reserved		
X20:20	reserved		

# Board 1 SKYPER® 32PRO R - Technical Explanations

## PIN Array – Secondary Side

### Connector X100, X200 (MOLEX Series 41791, Part Number 26-60-4050)

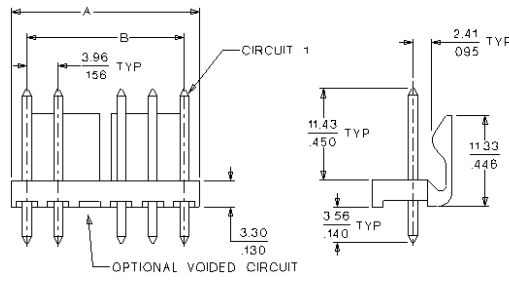

The drawing shows a top view and a side view of the connector. Dimensions include: A (total length), B (pitch), 3.96 / 156 TYP (pitch between pins), 2.41 / 095 TYP (pin diameter), 11.43 / 450 TYP (pin height), 11.33 / 446 (pin height to base), 3.30 / 130 (base width), 3.56 / 140 TYP (base thickness), and 2.41 / 095 TYP (pin diameter). Labels include 'CIRCUIT 1' and 'OPTIONAL VOIDED CIRCUIT'.

Product information of suitable female connectors and distributor contact information is available at e.g. <http://www.molex.com> (e.g. series 41695).

PIN	Signal	Function	Specification
X100:01	EMITTER_TOP	Emitter output TOP IGBT	
X100:02	reserved		
X100:03	GATE_TOP	Gate output TOP IGBT	
X100:05	VCE_TOP	Collector output TOP IGBT	
X200:01	EMITTER_BOT	Emitter output BOT IGBT	
X200:02	reserved		
X200:03	GATE_BOT	Gate output BOT IGBT	
X200:05	VCE_BOT	Collector output BOT IGBT	

### Connector X12 (MOLEX Series 41791, Part Number 26-60-4020)

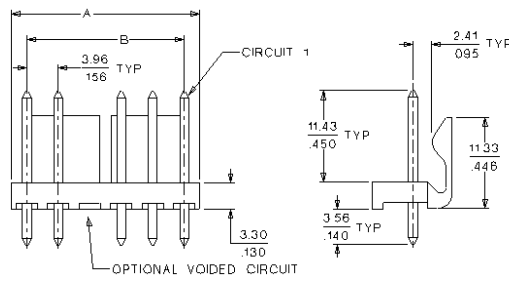

The drawing shows a top view and a side view of the connector. Dimensions include: A (total length), B (pitch), 3.96 / 156 TYP (pitch between pins), 2.41 / 095 TYP (pin diameter), 11.43 / 450 TYP (pin height), 11.33 / 446 (pin height to base), 3.30 / 130 (base width), 3.56 / 140 TYP (base thickness), and 2.41 / 095 TYP (pin diameter). Labels include 'CIRCUIT 1' and 'OPTIONAL VOIDED CIRCUIT'.

Product information of suitable female connectors and distributor contact information is available at e.g. <http://www.molex.com> (e.g. series 41695).

PIN	Signal	Function	Specification
X12:01	SENSE_TEMP_T1	Input temperature signal	NTC + / PTC +
X12:02	SENSE_TEMP_T2	Input temperature signal	NTC - / PTC -

## Signal IF\_CMN\_nHALT

The Halt Logic Signals PRIM\_HALT\_IN and PRIM\_HALT\_OUT of the driver core are coupled to one bidirectional signal (IF\_CMN\_nHALT) with dominant recessive behaviour. IF\_CMN\_nHALT shows the driver core status. When IF\_CMN\_nHALT is HIGH (recessive), the driver core is ready to operate. When IF\_CMN\_nHALT is LOW (dominant), the driver core is disabled / not ready to operate because of e. g. detected failure or driver core system start.

A controller can hold with the IF\_CMN\_nHALT signal the driver core in a safe state (e.g. during a start up of a system or gathered failure signal of other hardware) or generate a coeval release of paralleled driver. Furthermore, paralleled drivers can send and receive IF\_CMN\_nHALT signals among each other by using a single-wire bus.

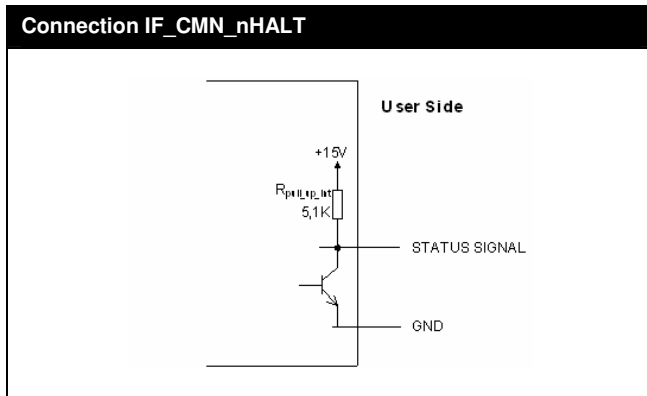

## Setting Dead Time

DT adjustment		
Designation	Shape	Setting
R43 (connected to GND)	0603 (SMD)	PRIM_CFG_TDT2_IN Factory setting: 0Ω
R44 (connected to GND)	0603 (SMD)	PRIM_CFG_SELECT_IN Factory setting: not equipped
R45 (connected to GND)	0603 (SMD)	PRIM_CFG_TDT3_IN Factory setting: 0Ω
R46 (connected to GND)	0603 (SMD)	PRIM_CFG_TDT1_IN Factory setting: not equipped

Factory setting: 3,3μs

## Setting Dynamic Short Circuit Protection

$R_{CE}$ & $C_{CE}$			
Designation	Shape	Setting	
R162	1206 (SMD)	$R_{CE}$ Factory setting: not equipped	TOP
C150	1206 (SMD)	$C_{CE}$ Factory setting: not equipped	TOP
R262	1206 (SMD)	$R_{CE}$ Factory setting: not equipped	BOT
C260	1206 (SMD)	$C_{CE}$ Factory setting: not equipped	BOT

# Board 1 SKYPER® 32PRO R - Technical Explanations

## Collector Series Resistance

$R_{VCE}$			
Designation		Setting	
R150	MiniMELF (SMD)	$R_{VCE}^*$ Factory setting: not equipped	TOP
R250	MiniMELF (SMD)	$R_{VCE}^*$ Factory setting: not equipped	BOT

\* 1200V IGBT operation: 0Ω  
1700V IGBT operation: 1kΩ / 0,4W

## Adaptation Gate Resistors

$R_{Gon}$ & $R_{Goff}$			
Designation	Shape	Setting	
R151, R152, R153 (parallel connected)	MiniMELF (SMD)	$R_{Gon}$ Factory setting: not equipped	TOP
R154, R155, R156 (parallel connected)	MiniMELF (SMD)	$R_{Goff}$ Factory setting: not equipped	TOP
R251, R252, R253 (parallel connected)	MiniMELF (SMD)	$R_{Gon}$ Factory setting: not equipped	BOT
R254, R255, R256 (parallel connected)	MiniMELF (SMD)	$R_{Goff}$ Factory setting: not equipped	BOT

## Setting Soft Turn-Off

$R_{Goff\_SC}$			
Designation	Shape	Setting	
R160, R161 (parallel connected)	MiniMELF (SMD)	$R_{Goff\_SC}$ Factory setting: not equipped	TOP
R260, R261 (parallel connected)	MiniMELF (SMD)	$R_{Goff\_SC}$ Factory setting: not equipped	BOT

## Over Temperature Protection Circuit (OTP)

The external error input SEC\_TOP\_ERR\_IN on the secondary side (high potential) of the driver core is used for an over temperature protection circuit to place the gate driver into halt mode.

### Dimensioning OTP

If no temperature sensor is connected:

- R172: 0Ω (factory setting: not equipped)
- R175: not equip (factory setting: equipped)
- R177: not equip (factory setting: not equipped)

If a NTC temperature sensor is connected:

1. Define an over temperature trip level according to the application.
2. Calculate the nominal ohmic resistance value of the temperature sensor at the defined trip level according to the IGBT Module explanation.
3. The trip level on the adapter board is set with R172 (factory setting: not equipped) by using the calculated resistance value.
4.  $R177 = 450k\Omega^2 / R_{NTC(@-40^\circ C)}[k\Omega]$  (factory setting: not equipped)
5. R175: equip (factory setting: equipped)

If a PTC temperature sensor is connected:

1. Define an over temperature trip level according to the application.
2. Calculate the nominal ohmic resistance value of the temperature sensor at the defined trip level according to the IGBT Module explanation.
3. The trip level on the adapter board is set with  $R177 = 450k\Omega^2 / R_{calculated\_resistance}[k\Omega]$  (factory setting: not equipped)
4. R172 = 0Ω (factory setting: not equipped)
5. R175: equip (factory setting: equipped)

## Mounting Notes

### Driver Core Mounting

1. Soldering of components (e.g. R<sub>Gon</sub>, R<sub>Goff</sub>, etc.) on adaptor board.
2. Insert driver core into the box connector on adaptor board.
3. The connecting leads between board and power module should be as short as possible (max. 20cm), the leads should be twisted.

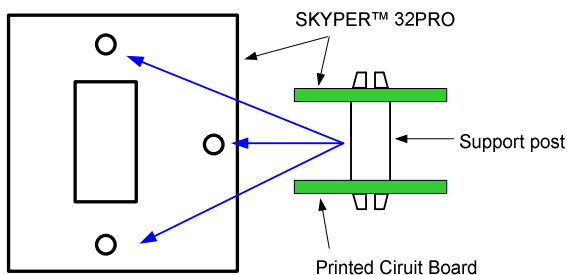

The connection between driver core and adaptor board should be mechanical reinforced by using support posts. The posts have to be spaced between driver core and adaptor board.

Product information of suitable support posts and distributor contact information is available at e.g. <http://www.richco-inc.com> (e.g. part number DLMSPM-8-01, LCBST-8-01).



## Schematic II Adaptorboard

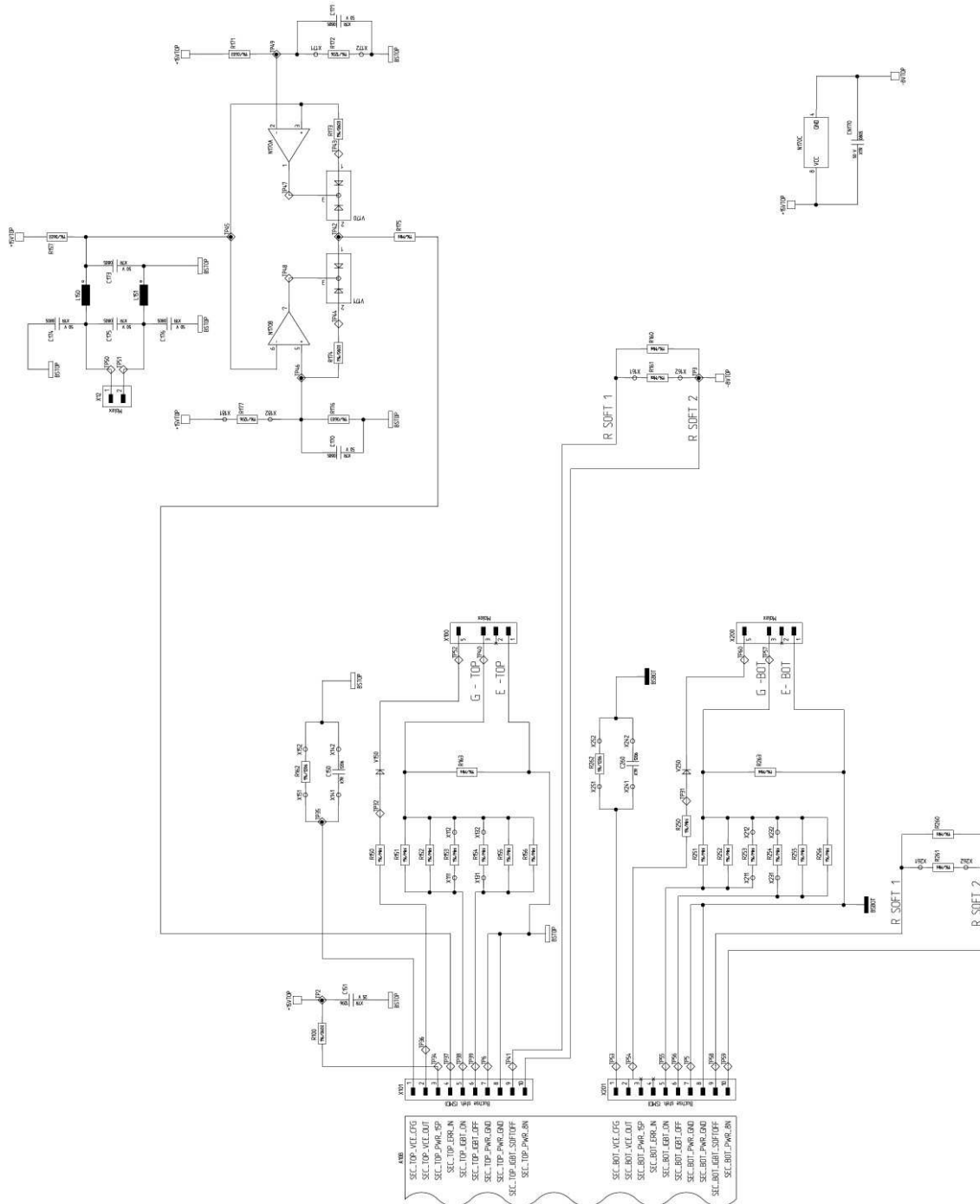

# Board 1 SKYPER® 32PRO R - Technical Explanations

## Parts List

### Parts List Adaptor Board

Count	Ref. Designator	Value	Pattern Name	Description
8	C170, C171, C173, C174, C175, C176, CD20, CN170,	100nF	0805 (SMD)	Capacitor X7R
6	C20, C21, C22, C23, C24, C25	1nF	0805 (SMD)	Capacitor X7R
1	C27	2,2µF	1210 (SMD)	Capacitor X7R
1	C28	220uF/35V	SMD	Longlife-Elko
1	C32	68pF	0603 (SMD)	Capacitor NP0
2	C35, C151	1uF	1206 (SMD)	Capacitor X7R
1	C36	100pF	0603 (SMD)	Capacitor NP0
1	D20	74C14	SOIC 14 (SMD)	Logic-IC 74C...
2	L150, L151	100uH	SIMID02 (SMD)	Inductor
1	N170	LM2904	SOIC 8 (SMD)	Operational Amplifier
1	R100	10,0Ohm	0603 (SMD)	1%
2	R157, R171	15,0KOhm	0603 (SMD)	1%
2	R163, R263	10,0KOhm	MiniMelf (SMD)	1%
3	R173, R174, R176	30,1KOhm	0603 (SMD)	1%
1	R175	5,62KOhm	MiniMelf (SMD)	1%
3	R28, R50, R52	10,0KOhm	MikroMelf (SMD)	1%
6	R30, R31, R32, R33, R34, R37	5,11KOhm	MikroMelf (SMD)	1%
1	R36	3,32KOhm	0603 (SMD)	1%
2	R43, R45	0,00Ohm	0603 (SMD)	
3	R47, R54, R56	10,0KOhm	0603 (SMD)	1%
1	R51	121KOhm	0603 (SMD)	1%
1	R53	100Ohm	MikroMelf (SMD)	1%
1	R57	1,50KOhm	MikroMelf (SMD)	1%
1	R58	1,00KOhm	0603 (SMD)	1%
2	R60, R61	2,00KOhm	0603 (SMD)	1%
1	R62	3,92KOhm	0603 (SMD)	1%
2	V150, V250	BY203/20S		High Voltage Diode
2	V170, V171	BAV70W	SOT323 (SMD)	Double Diode
1	V20	SMCJ15	DO214AB (SMD)	Suppressor Diode
5	V23, V25, V26, V27, V29	BC847B	SOT23 (SMD)	NPN-Transistor
1	V28	BZX284-C7V5	SOD110 (SMD)	Zener-Diode
4	X10, X11, X101, X201	RM2,54 10p.	SMD	Box Connector
2	X100, X200	5p.		Connector
1	X12	2p.		Connector
1	X20	20p.	SMD	Connector

TP: Test Point

Box Connector: SUYIN 254100FA010G200ZU

## DISCLAIMER

SEMIKRON reserves the right to make changes without further notice herein to improve reliability, function or design. Information furnished in this document is believed to be accurate and reliable. However, no representation or warranty is given and no liability is assumed with respect to the accuracy or use of such information. SEMIKRON does not assume any liability arising out of the application or use of any product or circuit described herein. Furthermore, this technical information may not be considered as an assurance of component characteristics. No warranty or guarantee expressed or implied is made regarding delivery, performance or suitability. This document supersedes and replaces all information previously supplied and may be superseded by updates without further notice.

SEMIKRON products are not authorized for use in life support appliances and systems without the express written approval by SEMIKRON.

[www.SEMIKRON.com](http://www.SEMIKRON.com)